

# datavideo

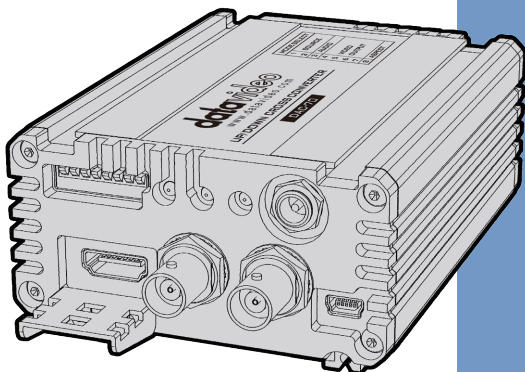

**UP / DOWN / CROSS  
CONVERTER  
DAC-70**

## **Instruction Manual**

[www.datavideo.com](http://www.datavideo.com)

# Table of Contents

<b>FCC COMPLIANCE STATEMENT</b> .....	<b>4</b>
<b>WARNINGS AND PRECAUTIONS</b> .....	<b>4</b>
<b>WARRANTY</b> .....	<b>5</b>
<i>STANDARD WARRANTY</i> .....	5
<i>THREE YEAR WARRANTY</i> .....	6
<b>DISPOSAL</b> .....	<b>7</b>
<b>1. INTRODUCTION</b> .....	<b>8</b>
FEATURES .....	8
<b>2. CONNECTIONS &amp; CONTROLS</b> .....	<b>9</b>
FRONT PANEL .....	9
REAR PANEL .....	10
<b>3. DIP SWITCH MODE SELECTION</b> .....	<b>12</b>
DIP SWITCH PIN 8 .....	13
PAN SCAN 16:9 .....	13
<b>4. DAC-70 CENTER UTILITY</b> .....	<b>14</b>
INFORMATION .....	14
VIDEO .....	15
AUDIO .....	18
PICTURE .....	19
SETTING .....	20
<b>5. FORMAT CONVERSION</b> .....	<b>22</b>

<b>6. FIRMWARE UPDATE.....</b>	<b>23</b>
<b>7. DIMENSIONS .....</b>	<b>24</b>
<b>8. SPECIFICATIONS.....</b>	<b>25</b>
<b>SERVICE &amp; SUPPORT.....</b>	<b>28</b>

#### **Disclaimer of Product and Services**

The information offered in this instruction manual is intended as a guide only. At all times, Datavideo Technologies will try to give correct, complete and suitable information. However, Datavideo Technologies cannot exclude that some information in this manual, from time to time, may not be correct or may be incomplete. This manual may contain typing errors, omissions or incorrect information. Datavideo Technologies always recommend that you double check the information in this document for accuracy before making any purchase decision or using the product. Datavideo Technologies is not responsible for any omissions or errors, or for any subsequent loss or damage caused by using the information contained within this manual. Further advice on the content of this manual or on the product can be obtained by contacting your local Datavideo Office or dealer.

## FCC Compliance Statement

This device complies with part 15 of the FCC rules. Operation is subject to the following two conditions:

1. This device may not cause harmful interference, and
2. This device must accept any interference received, including interference that may cause undesired operation.

## Warnings and Precautions

1. Read all of these warnings and save them for later reference.
2. Follow all warnings and instructions marked on this unit.
3. Unplug this unit from the wall outlet before cleaning. Do not use liquid or aerosol cleaners. Use a damp cloth for cleaning.
4. Do not use this unit in or near water.
5. Do not place this unit on an unstable cart, stand, or table. The unit may fall, causing serious damage.
6. Slots and openings on the cabinet top, back, and bottom are provided for ventilation. To ensure safe and reliable operation of this unit, and to protect it from overheating, do not block or cover these openings. Do not place this unit on a bed, sofa, rug, or similar surface, as the ventilation openings on the bottom of the cabinet will be blocked. This unit should never be placed near or over a heat register or radiator. This unit should not be placed in a built-in installation unless proper ventilation is provided.
7. This product should only be operated from the type of power source indicated on the marking label of the AC adapter. If you are not sure of the type of power available, consult your Datavideo dealer or your local power company.
8. Do not allow anything to rest on the power cord. Do not locate this unit where the power cord will be walked on, rolled over, or otherwise stressed.
9. If an extension cord must be used with this unit, make sure that the total of the ampere ratings on the products plugged into the extension cord do not exceed the extension cord rating.



10. Make sure that the total amperes of all the units that are plugged into a single wall outlet do not exceed 15 amperes.
11. Never push objects of any kind into this unit through the cabinet ventilation slots, as they may touch dangerous voltage points or short out parts that could result in risk of fire or electric shock. Never spill liquid of any kind onto or into this unit.
12. Except as specifically explained elsewhere in this manual, do not attempt to service this product yourself. Opening or removing covers that are marked “Do Not Remove” may expose you to dangerous voltage points or other risks, and will void your warranty. Refer all service issues to qualified service personnel.
13. Unplug this product from the wall outlet and refer to qualified service personnel under the following conditions:
  - a. When the power cord is damaged or frayed;
  - b. When liquid has spilled into the unit;
  - c. When the product has been exposed to rain or water;
  - d. When the product does not operate normally under normal operating conditions. Adjust only those controls that are covered by the operating instructions in this manual; improper adjustment of other controls may result in damage to the unit and may often require extensive work by a qualified technician to restore the unit to normal operation;
  - e. When the product has been dropped or the cabinet has been damaged;
  - f. When the product exhibits a distinct change in performance, indicating a need for service.

## **Warranty**

### ***Standard Warranty***

- Datavideo equipment is guaranteed against any manufacturing defects for one year from the date of purchase.
- The original purchase invoice or other documentary evidence should be supplied at the time of any request for repair under warranty.

- The product warranty period begins on the purchase date. If the purchase date is unknown, the product warranty period begins on the thirtieth day after shipment from a Datavideo office.
- All non-Datavideo manufactured products (product without Datavideo logo) have only one year warranty from the date of purchase.
- Damage caused by accident, misuse, unauthorized repairs, sand, grit or water is not covered under warranty.
- Viruses and malware infections on the computer systems are not covered under warranty.
- Any errors that are caused by unauthorized third-party software installations, which are not required by our computer systems, are not covered under warranty.
- All mail or transportation costs including insurance are at the expense of the owner.
- All other claims of any nature are not covered.
- All accessories including headphones, cables, batteries, metal parts, housing, cable reel and consumable parts are not covered under warranty.
- Warranty only valid in the country or region of purchase.
- Your statutory rights are not affected.

### ***Three Year Warranty***

- All Datavideo products purchased after July 1st, 2017 qualify for a free two years extension to the standard warranty, providing the product is registered with Datavideo **within 30** days of purchase.
- Certain parts with limited lifetime expectancy such as LCD panels, DVD drives, Hard Drive, Solid State Drive, SD Card, USB Thumb Drive, Lighting, Non-PCIe Card and third party provided PC components are covered for 1 year.
- The three-year warranty must be registered on Datavideo's official website or with your local Datavideo office or one of its authorized distributors within 30 days of purchase.



## Disposal

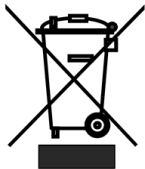

### **For EU Customers only - WEEE Marking**

This symbol on the product or on its packaging indicates that this product must not be disposed of with your other household waste. Instead, it is your responsibility to dispose of your waste equipment by handing it over to a designated collection point for the recycling of waste electrical and electronic equipment. The separate collection

and recycling of your waste equipment at the time of disposal will help to conserve natural resources and ensure that it is recycled in a manner that protects human health and the environment. For more information about where you can drop off your waste equipment for recycling, please contact your local city office, your household waste disposal service or the shop where you purchased the product.



**CE Marking** is the symbol as shown on the left of this page.

The letters "CE" are the abbreviation of French phrase "Conformité Européene" which literally means "European Conformity". The term initially used was "EC Mark" and it was officially replaced by "CE Marking" in the Directive 93/68/EEC in 1993. "CE Marking" is now used in all EU official documents.

# 1. Introduction

The Datavideo DAC-70 is a broadcast quality up/down/cross converter. The unit allows the user to configure the device using a simple DIP switch or on a USB 2.0 interface utility. The DAC-70 case LEDs indicate the currently selected video source. The DAC-70 gives the user the capability of sharing VGA, HDMI or SDI inputs in an HDMI or SDI environment.

Housed in a metal case, the DAC-70 is tough enough to withstand the knocks of fast-paced live production setups in ENG or any studio. Built to the same dimensions as Datavideo's range of converters, the DAC-70 can also be mounted into a standard 19" RMK-2 rack with a mix of other units.

That's Datavideo, sharing the value!

## Features

- 3G-SDI technology with full 10 bit processing and low SDI jitter
- DC or AC operation for convenient field or studio use
- DIP switch setup
- Micro USB 2.0 interface for firmware updates

### Video Inputs - Choose from:

- HD / SD-SDI [BNC] with active SDI loop through
- HDMI
- VGA [15PIN D-Sub Female]

### Audio Inputs

- HDMI / SDI embedded multi-channel audio
- Unbalanced RCA Phono sockets [Stereo L&R Channels @ line level]

### Video outputs

- Two HD / SD-SDI [BNC] with embedded audio
- HDMI with embedded audio
- Simultaneous HDMI & SDI outputs regardless of settings

### Control

- Windows only software utility for local configuration and control via Micro-USB 2.0 interface

**Note:** The DAC-70 supports HDCP copy protection, i.e. the DAC-70 outputs no signal when the user supplies protected DVD or BD video.



## 2. Connections & Controls

### Front Panel

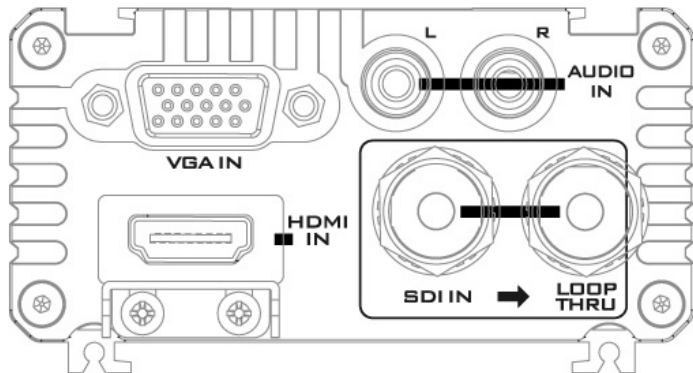

#### VGA IN

VGA IN connects the VGA equipment.

#### Supported Resolutions

800x600@60Hz, 1024x768@60Hz, 1280x1024@60Hz  
1366x768@60Hz, 1400x1050@60Hz, 1600x1200@60Hz  
1280x720@60Hz, 1920x1080@60Hz



#### HDMI IN

HDMI IN connects the HDMI equipment.

#### HDCP Copy Protection

For legal reasons, the HDMI input is unable to pass on video from copy protected HDMI sources.



#### Audio IN

Inputs for 2 channels of RCA unbalanced audio

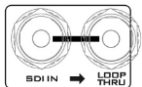

### HD-SDI IN & Output (Loop Thru)

HD-SDI input and loop-through output connectors.

Left BNC connector: HD/SD-SDI Input

Right BNC connector: Loop Thru Output

## Rear Panel

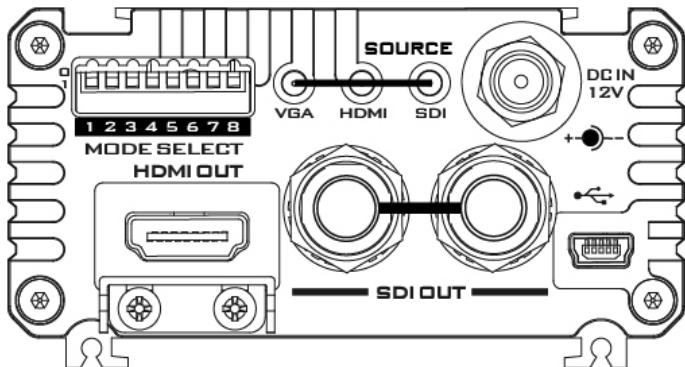

### Mode Select (DIP switch)

Use the DIP switch to manually set the DAC-70 modes; please refer to the [DIP Switch Mode Selection](#) section for details.



### Source Indicator

Indicates video source format.



### HDMI OUT

HDMI Video and Audio output.

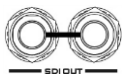

### HD/SD - SDI OUT

SDI Video and Audio output.



### DC IN Socket

Connects the supplied 12V PSU to this socket. The connection can be secured by screwing the outer fastening ring of the DC IN plug to the socket.



### USB

The USB port connects the DAC-70 to the PC for **Firmware upgrade** and access to the **DAC-70 Center Utility**.

### 3. DIP Switch Mode Selection

			
<b>DIP SW 1/2</b>	<b>DIP SW 3</b>	<b>DIP SW 4/5/6/7</b>	<b>DIP SW 8</b>
<b>Source</b>	<b>Audio</b>	<b>Video Output</b>	<b>Aspect Ratio</b>
00 VGA 01 HDMI 10 SDI 11 PC	0 INT. 1 EXT.	0000 1920x1080 p60 0001 1920x1080 p59.94 0010 1920x1080 p50 0011 1920x1080 p30 0100 1920x1080 p29.97 0101 1920x1080 p25 0110 1920x1080 p24 0111 1920x1080 p23.98 1000 1920x1080 i60 1001 1920x1080 i59.94 1010 1920x1080 i50 1011 1280x720 p60 1100 1280x720 p59.94 1101 1280x720 p50 1110 720x480 i59 (525i) 1111 720x570 i50 (625i)	0 Full Screen 1 Pan Scan 16:9 / Keep Aspect Ratio (1:1)
DIP Switch is disabled when SOURCE is set to 11.		Select "Pan Scan 16:9" or "Keep Aspect Ratio" (1:1) on the DAC-70 Center Utility. Please refer to the next page for details.	

## DIP Switch PIN 8

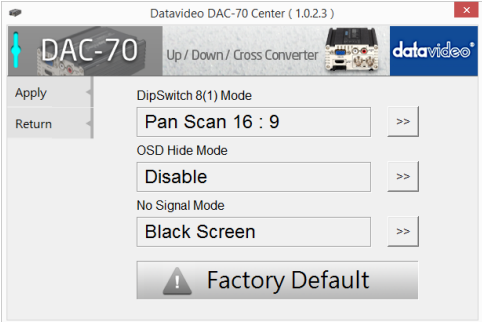
0	Full Screen
1	<p>Pan Scan 16:9 / Keep Aspect Ratio (1:1)</p> <p>On the MAIN page of the DAC-70 Center Utility, click the <b>Setting</b> tab to enter the page on which the user is allowed to select “Pan Scan 16:9” or “Keep Aspect Ratio” (1:1). Reboot the device after setting.</p> 

## PAN SCAN 16:9

If the Pan Scan 16:9 mode is selected, the table below provides an illustration as to how the image will be displayed on the 16:9 and 4:3 monitors given that their respective input aspect ratios are 4:3 and 16:9.

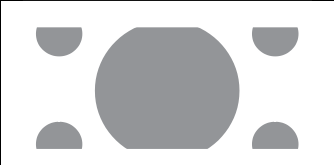
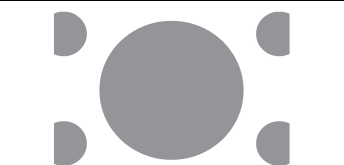
Input 4:3 / Output 16:9	Input 16:9 / Output 4:3
	

## 4. DAC-70 Center Utility

DAC-70 Center Utility is a Graphical User Interface that allows the user to obtain the device information and perform various video and audio settings. To use the utility, the user should first copy the **DAC-70 Center.exe** utility software from the installation CD to the computer running Windows. After that, connect the DAC-70 to the same computer using the USB cable. Switch on the DAC-70 and open the DAC-70 Center Utility software.

### Information

- Click the **Information tab** to obtain the information on input format and firmware version.

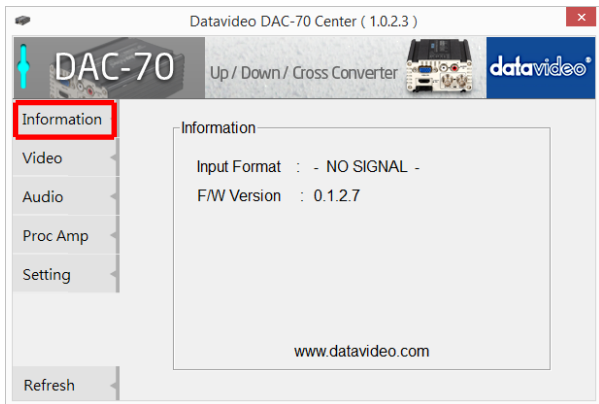

## Video

- Click the **Video tab** to enter the video setup page.

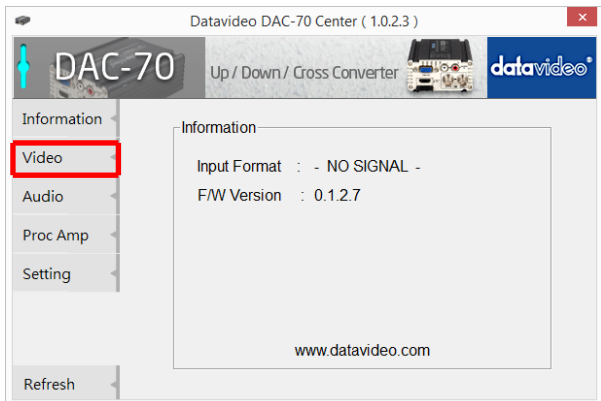

- On the video setup page, click the **Video Setting** button to enter the video configuration page.

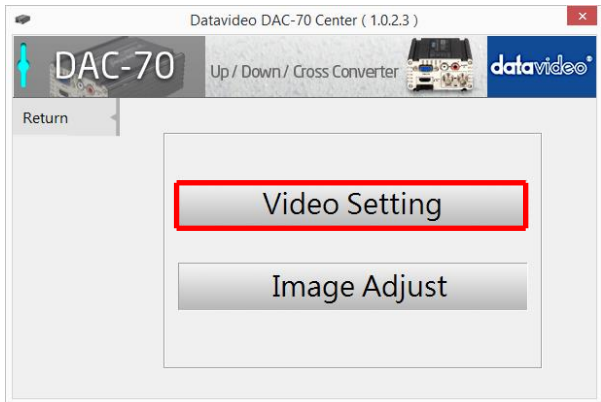

- Set the input source, aspect ratio and output format.

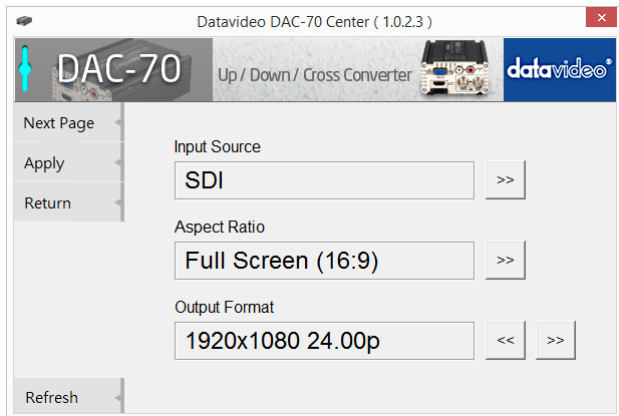

- Click **Next Page**

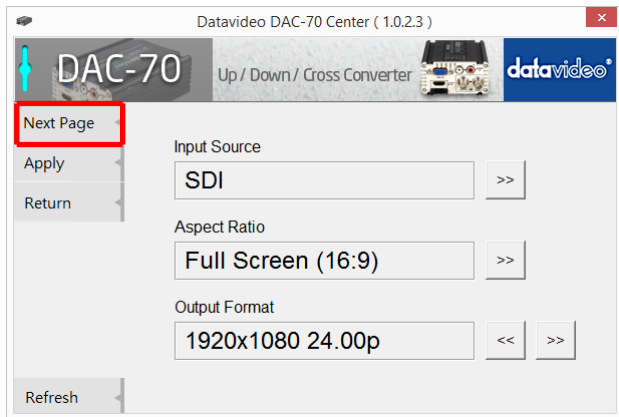



- Set the HDMI Output Colour, HDMI Output Range and Edge Enhance. Enable 3G Level B if your video resolution is 1080p50/59.94/60.

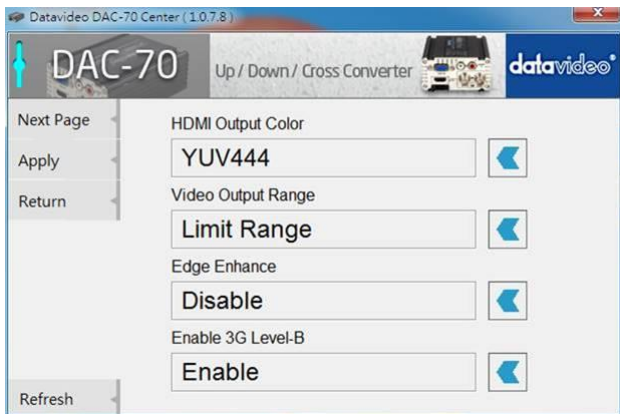

- Click **Apply** after all settings are configured.

**Note 1:** When “**Input Source**” is set to “**VGA**”, the user will be allowed to adjust “**Horizontal Position**” and “**Vertical Position**” in the **Image Adjust**.



**Note 2:** When “**Aspect Ratio**” is set to “**Under Scan**”, the user will be allowed to adjust “**Horizontal Size**” and “**Vertical Size**” in the **Image Adjust**.

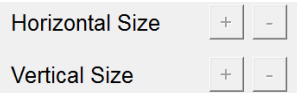

## Audio

- Click the **Audio tab** to set audio parameters.

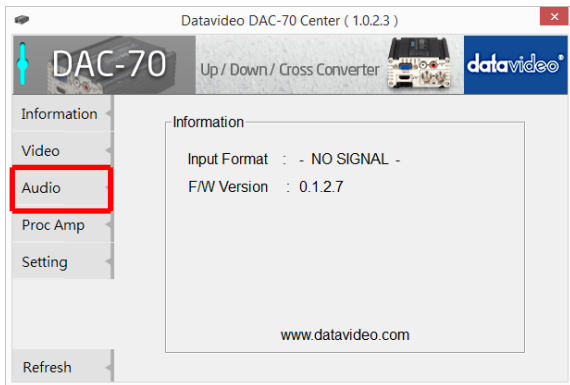

- Click **Apply** after setting Audio Mute, Audio Source and Audio Level.

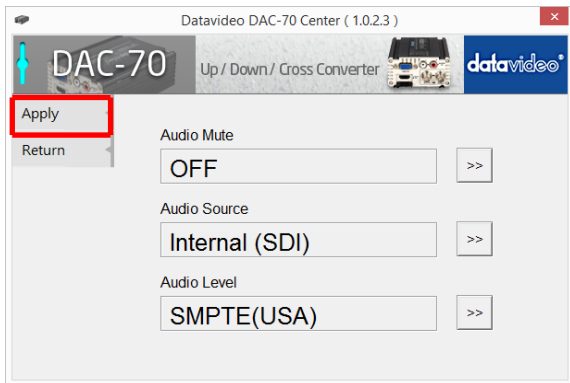

**Note 1:** Audio Level allows the user to select between EBU and SMPTE standards.

**Note 2:** Audio Level setting is enabled only for RCA input.

## Picture

- Click the **Proc AMP** tab to adjust the picture settings.

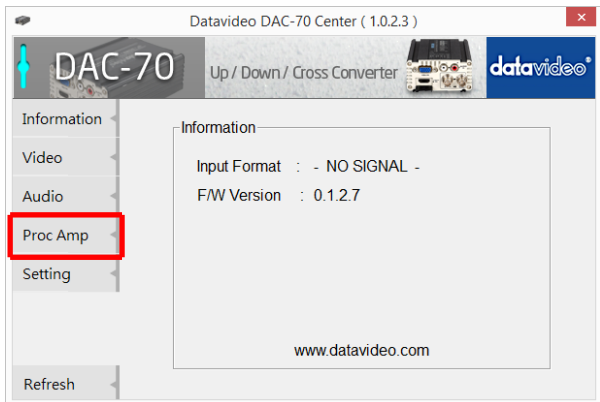

- Set the **Brightness**, **Contrast**, **Hue**, and **Saturation** levels on the Proc Amp setup page.

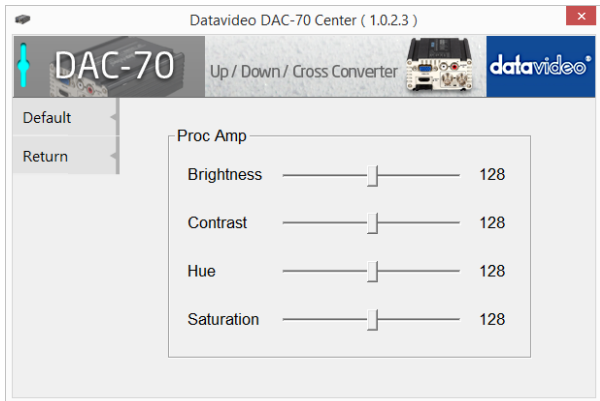

## Setting

- To restore the factory default settings, click the **Setting** tab.

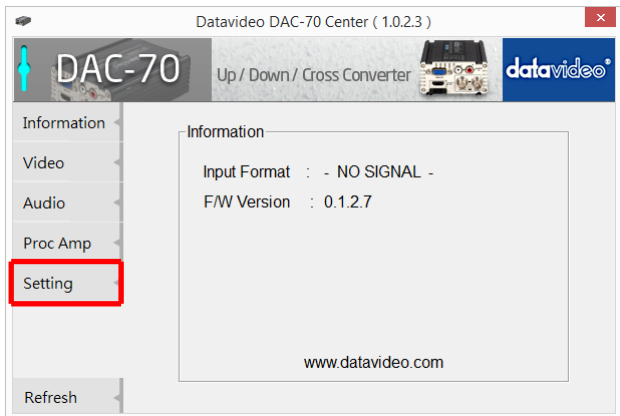

- Click the **Factory Default** button to reset the DAC-70 to factory defaults.

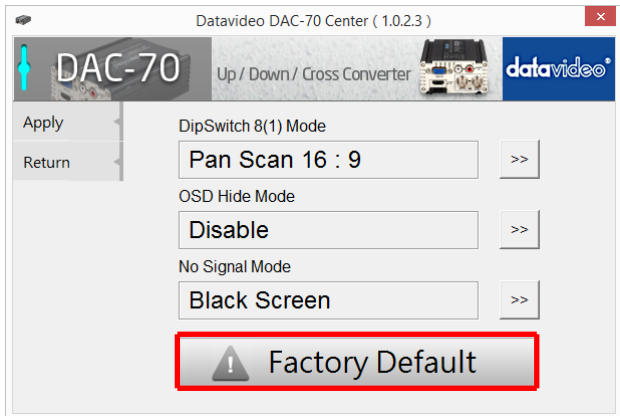

In addition, the user can also set **Dip Switch 8 (1) Mode**, **OSD Hide Mode** and **No Signal Mode**.

**Dip Switch 8 (1) Mode**      When 8<sup>th</sup> bit of the DIP switch is set to 1, this option allows the user to select Pan Scan 16:9 or Keep Aspect Ratio (1:1).

**OSD Hide Mode**              When enabled, source information and output resolution will not be displayed on the information page upon resolution change.

**No Signal Mode**              This sets how the screen looks like when there is no signal.

## 5. Format Conversion

The DAC-70 allows users to up-convert, down-convert and cross-convert between different resolutions and I/O interfaces. See the table below for details.

Input				Up/Down/Cross	Output					
3G-SDI/ HDMI	1080p 60 / 50 1080p 59.94	SD-SDI/ HDMI	NTSC(525i) PAL(625i) 576p,480p,576i,480i		3G-SDI/ HDMI	1080p 60 / 50 1080p 59.94	HD-SDI/ HDMI	1080p 30 / 25 / 24 1080p 29.97 1080psf 29.97 1080p 23.98 1080psf 23.98 1080i 60 / 50 1080i 59.94 720p 60 / 50 720p 59.94	SD-SDI/ HDMI	NTSC(525i) PAL(625i)
HD-SDI/ HDMI	1080p 30 / 25 / 24 1080psf 30 / 25 / 24 1080p 29.97 1080psf 29.97 1080p 23.98 1080psf 23.98 1080i 60 / 50 1080i 59.94 720p 60 / 50 720p 59.94	VGA/ HDMI	800x600@60Hz 1024x768@60Hz 1280x1024@60Hz 1366x768@60Hz 1400x1050@60Hz 1600x1200@60Hz 1280x720@60Hz 1920x1080@60Hz							

## 6. Firmware Update

From time to time Datavideo may release new firmware to either add new features or fix reported bugs in the current DAC-70 firmware. Customers can update the DAC-70 firmware themselves or contact their local dealer for assistance.

This section describes the firmware update process and it should take **approximately 10 minutes of total time to complete**. Please note the **current DAC-70 settings**. *The update process should not be interrupted* once started as this could result in a non-responsive unit.

---

### A working DAC-70 requires the following:

1. The latest firmware file for the DAC-70. This can be obtained from your local Datavideo dealer or office.
  2. The Upload Firmware utility. This can also be obtained from your local Datavideo dealer or office.
  3. A Windows PC with USB 2.0 port.
  4. A USB A to micro USB cable (USB 2.0).
- 

### How to update the DAC-70 firmware

1. Switch off the DAC-70 power.
2. Save the latest **firmware** file and the **Upload Firmware utility** to the PC desktop.
3. Use USB 2.0 cable to connect the DAC-70 to the computer.
4. Open the Datavideo Upload Firmware utility, which will show **Disconnected** and the connect button is greyed out.
5. Switch on the DAC-70 power and the connect button will now be enabled. Click the connect button and the Utility will show **Connected**.
6. Click the Open File button and select the new firmware file.
7. Click the Start button and wait for the progress bar to finish.
8. After the update is finished, the utility will show **PASS** to confirm that the unit has been updated successfully.
9. The utility will automatically disconnect the DAC-70 unit.
10. Unplug the USB cable from the DAC-70 and power cycle the unit.
11. The updated DAC-70 is now ready for use.



DataVideo Upload Firmware.exe  
DataVideo Upload Firmware  
Datavideo Technologies Co., Ltd

## 7. Dimensions

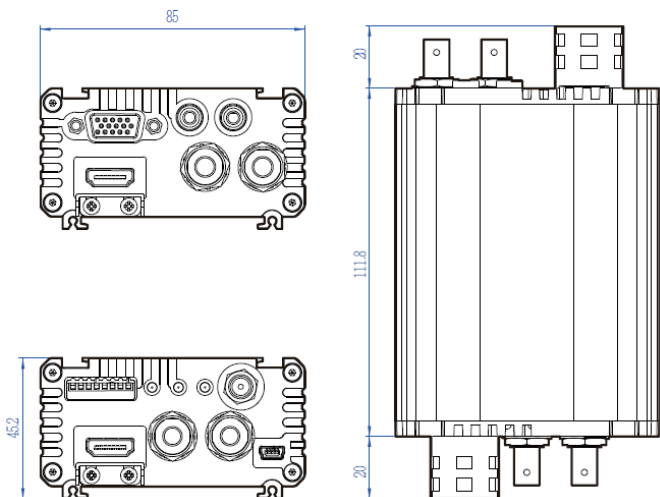

All measurements in millimeters (mm)



## 8. Specifications

<b>Input</b>	VGA x 1 HDMI x 1 HD/SD-SDI x 1 Analog Audio L/R
<b>Output</b>	SDI x 2 HDMI x 1 SDI Loop thru BNC (front panel)
<b>Micro USB</b>	Firmware upgrade Aspect ratio mode selection
<b>Video Input Format</b>	<p><b>SDI (YUV)</b> 1080p60/59.94/50, 1080p30/29.97/25/24/23.98 1080psf30/29.97/25/24/23.98 1080i60/59.94/50, ,720p60/59.94/50 525i, 625i</p> <p><b>HDMI (YUV / RGB)</b> 1080p60/59.94/50, 1080p30/29.97/25/24/23.98 1080psf30/29.97/25/24/23.98 1080i60/59.94/50, 720p60/59.94/50 480p, 576p, 480i, 576i 800x600@60Hz, 1024x768@60Hz, 1280x1024@60Hz 1366x768@60Hz, 1400x1050@60Hz, 1600x1200@60Hz</p> <p><b>VGA (RGB)</b> 800x600@60Hz, 1024x768@60Hz, 1280x1024@60Hz 1366x768@60Hz, 1400x1050@60Hz, 1600x1200@60Hz 1280x720@60Hz, 1920x1080@60Hz</p>
<b>Video Output Format</b>	<p><b>SDI / HDMI</b> 1080p60/59.94/50, 1080p30/29.97/25/24/23.98 1080i60/59.94/50, 720p60/59.94/50 525i, 625i</p>

<b>Audio Format</b>	<p><b>Input</b>  Analog Audio L/R : stereo audio  SDI / HDMI embedded audio up to 8CH, 48KHz, PCM audio  HDMI embedded audio up to 8CH, 44.1/48/96KHz, PCM audio</p> <p><b>Output</b>  SDI embedded audio up to 8CH, 48KHz, PCM audio  HDMI embedded audio up to 8CH, 48KHz, PCM audio</p>
<b>Operating Temperature</b>	0~40°C [32~104°F]
<b>Storage Temperature</b>	-10~ +60°C
<b>Dimensions</b>	144.8mm(L) x 85mm(W) x 45.2mm(H)
<b>Certifications</b>	CE/FCC

## Notes

---

## Service & Support

It is our goal to make your products ownership a satisfying experience. Our supporting staff is available to assist you in setting up and operating your system. Please refer to our web site [www.datavideo.com](http://www.datavideo.com) for answers to common questions, support requests or contact your local office below.



Please visit our website for latest manual update.

<https://www.datavideo.com/product/DAC-70>

**datavideo**  
[www.datavideo.com](http://www.datavideo.com)



@DatavideoUSA @DatavideoIndia2016  
@DatavideoEMEA @Datavideojapan  
@DatavideoTaiwan @DatavideoLatam  
@DatavideoAsia @DatavideoBrasil



@Datavideo  
@Datavideo\_EMEA  
@Datavideo\_Taiwan



@DatavideoUSA  
@DVTWDCVN



@DatavideoUSA  
@DatavideoEurope

All the trademarks are the properties of their respective owners.  
Datavideo Technologies Co., Ltd. All rights reserved 2020